



Price Page

Don-jo

Vendor Site

Wall Bumpers

1400

1" Diameter

With Anchor Screw - Cast Brass

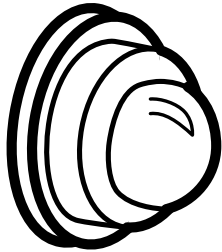

Stocked Product

1400 - 613, 626

1406/1407 - 605, 613, 619, 625, 626

1406

2 1/2" Diameter

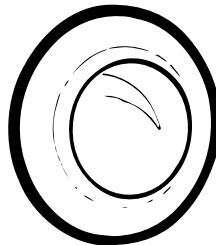

Plastic Anchor & Plastic Dry Wall Anchor

Wrought Material

1407

2 1/2" Diameter

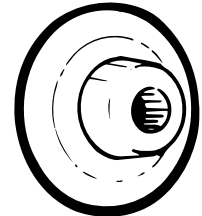

1440

Low Style

1/8" H x 1 5/8"

Diameter Base

W/S & MS & Exp Shield & Plastic Anchor

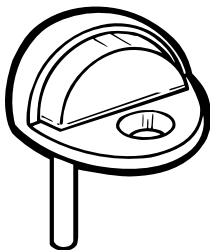

Floor Stops

Stocked Product

1440 - 605, 613, 619, 625, 626

1442 - 605, 613, 619, 625, 626

1442

High Style

3/8" H x 1 5/8"

Diameter Base

W/S & MS & Exp Shield & Plastic Anchor

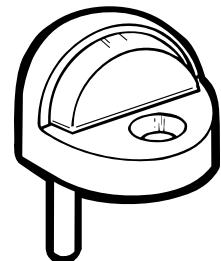

Door Holder

1467

3" Projection

Solid Brass Material

SMS Fastener

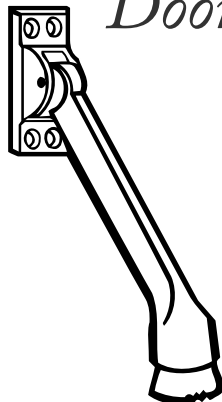

Stocked Product

1467 - 605, 613, 626



Price Page

Don-jo

Vendor Site

Push & Pull Plates, Pull Handles

35 Door Pull

5 1/2" CTC

6 5/8" x 1 3/4" x 1 5/16"

• Dimensions - Overall x Projection x Clearance



Stocked Product

35 - 605, 613, 630

70 - 605, 613, 626, 630

71 - 605, 613, 626, 629, 630

7015 - 605, 613, 626, 630

7115 - 605, 613, 626, 629, 630

70,71 Push Plate

70 - 3 1/2" x 15"

71 - 4" x 16"

Beveled edges, adhesive mounting,

Rounded corners

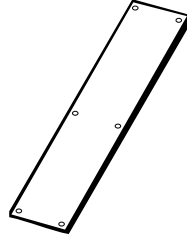

7015, 7115 Pull Plate

7015 - 3 1/2" x 15"

7115 - 4" x 16"

6" CTC

3/4" diameter pull

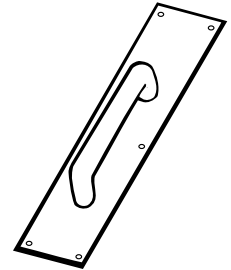

Door Silencers

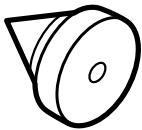

1608

For Metal frame

Gray Rubber

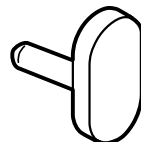

1609

For Wood frame

Gray Rubber

Strikes

9234

2 3/4" x 1 1/8"

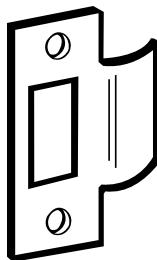

ST161

4 7/8" x 1 1/4"

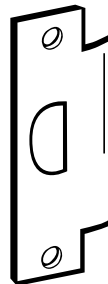

ST214

2 1/4" x 1 1/4"

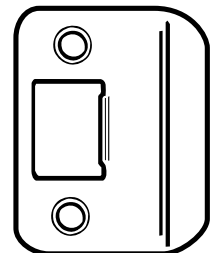

Stocked Product

9234 - 605, 630

ST161 - 605, 606, 613, 625, 626

ST214 - 605, 630



Price Page

Don-jo - *Extended Lip Strikes*

Vendor Site

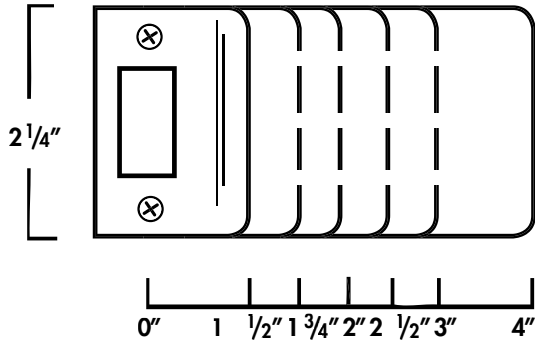

2-1/4" Extended Lip Strike

Number	Dimension
EL102	2-1/4" X 2"
EL115	2-1/4" X 1-1/2"
EL125	2-1/4" X 2-1/2"
EL175	2-1/4" X 1-3/4"

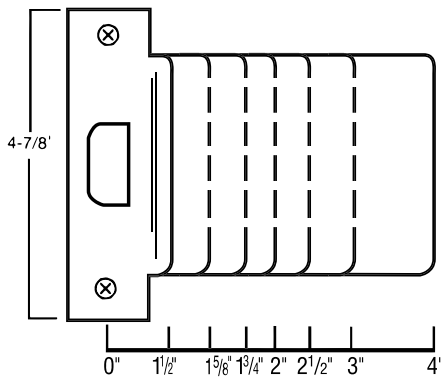

4-7/8" Extended Lip ANSI Strike

Number	Dimension
EST102	4-7/8" X 2"
EST115	4-7/8" X 1-1/2"
EST125	4-7/8" X 2-1/2"
EST158	4-7/8" X 1-5/8"
EST175	4-7/8" X 1-3/4"

Stocked Product

2-1/4" Extended Lip Strike

- EL102 - DU, 605, 619, 630
- EL115 - DU, 605, 619, 630
- EL125 - DU, 630
- EL175 - DU, 605, 619, 630

4-7/8" Extended Lip ANSI Strike

- EST102 - 630
- EST115 - 630
- EST125 - 630
- EST158 - 630
- EST175 - 630
- EST102 - 605, 630
- EST115 - 605, 630
- EST175 - 605, 630



Price Page

Don-jo - Architectural Accessories

Vendor Site

AR335

Use with levers on 1 3/8" door
(2 per pack)
3-1/2" Diameter
Finish - 630

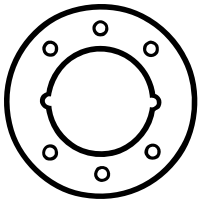

BF161

Covers up to 2 1/8" Hole
2-5/8" Diameter
Finish - Silver Coated

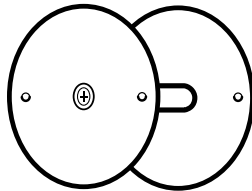

BF178

Covers up to 1 1/2" Hole
1-7/8" Diameter
Finish - Silver Coated

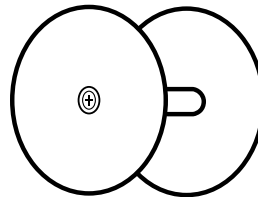

CV86

Converts 86
Cut out to 161
8" x 1-1/4"
Finish - Prime Coated



DSP135

Scar Plate
Fits under Deadbolt
Collars 3-1/2" OD, 1-1/2" ID
Finish 630

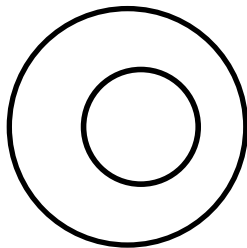

EF86

86 cut out
8" x 1 1/4" x 3/16"
Finish - Prime Coated



EF161 EF161S

2-1/4" x 1-1/8"
2-3/4" x 1-1/8"
Cut out
Finish - Prime Coated

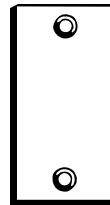

FF45

Frame hinge cut out
4-1/2" x 1-5/8"
Finish - Prime Coated

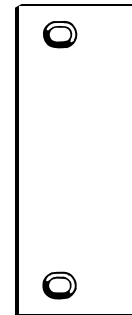

FS260PC

ANST strike cut out
Finish - Prime Coated
4-7/8" X 1-1/4"



HF45

Door hinge cut out
4-1/2" x 1-3/4"
Finish - Prime Coated



SHF45

4-1/2" x 1-1/2"
Finish - Prime Coated

HS060

16 (.060) Gauge Hinge shime
HS090
13 (.090) Gauge Hinge shime
Finish - Prime Coated

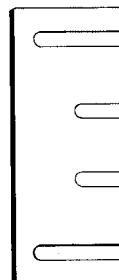

SP135

Scar Plate
Fits under Rose or
Key in knob or Deadbolt
3-1/2" OD, 2-1/8" ID
Finish 630

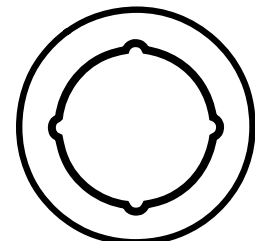



Price Page

Don-jo

Vendor Site

Lock Guard Plates

BLP107/BLP207

For Key-In-Lever Locks with up to 3-3/4" Escutcheon width

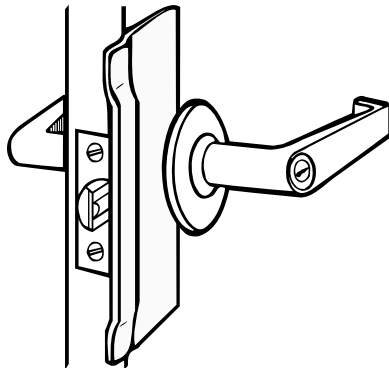

Stocked Product

BLP107 630
BLP207 Silver Coated

LP111
LP211

For Outswinging Doors
Completely Covers Strike Plate
3-1/2" Escutcheon width

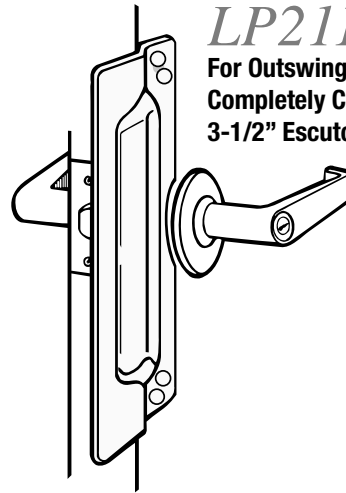

Stocked Product

LP111 630
LP211 Silver Coated

PLP111/PLP211

Latch Protector For Outswinging Doors (no pin)
3-1/2" Escutcheon width

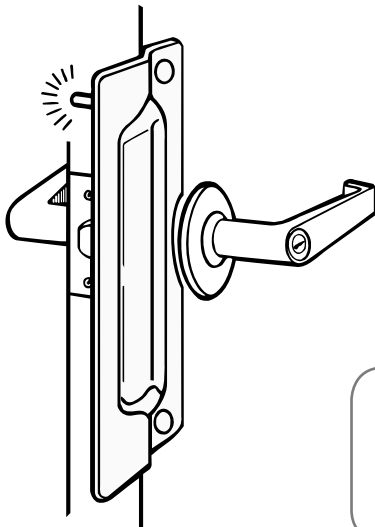

PLP

Stocked Product

PLP111 630
PLP211 626
PMLP111 630

PMLP111

Pin Latch Protector For Outswinging Doors
3-1/2" Escutcheon width

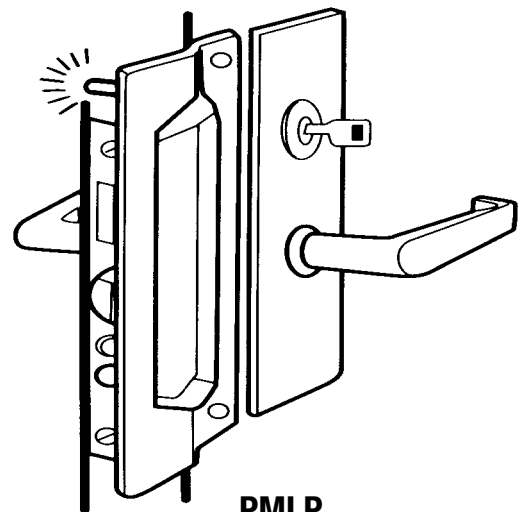

PMLP



Price Page

Don-jo - Signs & Decals

Vendor Site

Braille Translation on all Plastic Signs

Title 24 Signs



CHS-1



CHS-2



CHS-3



HS-9070-46



HS-9070-48



HS-9070-47

Sign Size 1 3/4" x 6"

Raised White Lettering

ADA Signs



HS-9070-35



HS-9070-01



HS-9070-05



HS-9070-32

Decal



HD-1
4" x 4"

White on Blue

THIS DOOR TO REMAIN UNLOCKED DURING BUSINESS HOURS

DD-1/DD-2

THESE DOORS TO REMAIN UNLOCKED DURING BUSINESS HOURS

DD-3/DD-4

1 1/2" x 24"

DD1 Black on Clear

DD2 White on Black

DD3 Black on Clear

DD4 White on Black

THIS DOOR TO REMAIN UNLOCKED WHILE BUILDING IS OCCUPIED

DD-5/DD-6

THESE DOORS TO REMAIN UNLOCKED WHILE BUILDING IS OCCUPIED

DD-7/DD-8

1 1/2" x 24"

DD5 Black on Clear

DD6 White on Black

DD7 Black on Clear

DD8 White on Black



Price Page

Don-jo - Architectural Accessories

Vendor Site

#K0050

ANSI J102 Metal

**Used on doors subject to marring
or damage from foot traffic.**

COMMERCIAL KICK PLATES

- Individually packaged with screws
- Fully threaded to the head stainless steel sheet metal screws plated to finish
- Beveled
- Commercial grade thickness
- Kick plate screws only \$0.40 list each
Specify 9DJOKPS + FINISH

Stocked Product

P/N	Size	Finishes
K0050	6"x34"	630
K0050	8"x34"	605, 613, 630
K0050	10"x32"	630
K0050	10"x34"	605, 613, 628, 630
K0050	10"x40"	605, 613, 630
K0050	10"x46"	630
K0050	12"x34"	630

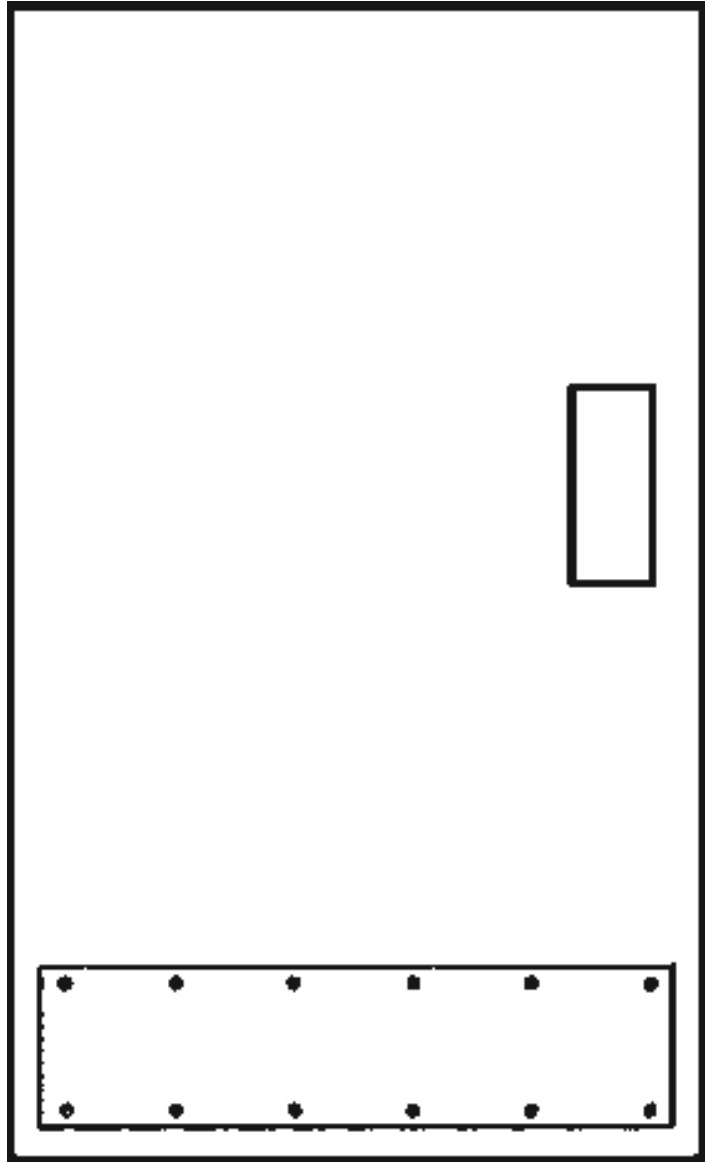



Price Page

Don-jo

Vendor Site

Wrap Around

The Classic Wrap-Around advantage

22(.32) Gauge

includes:

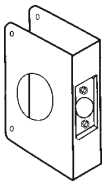
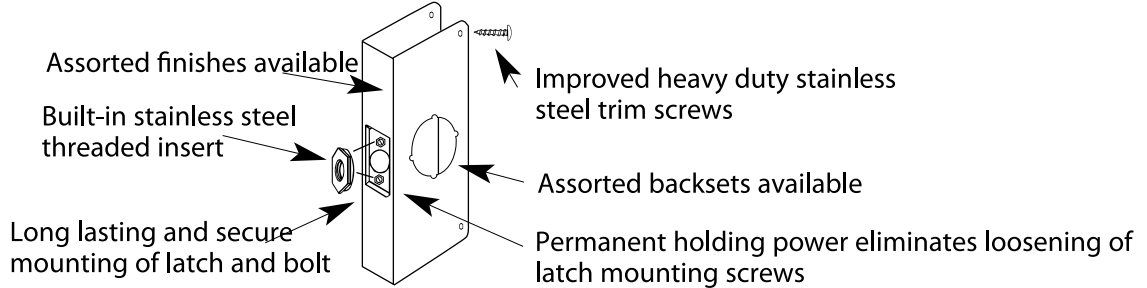

Stocked Product

For deadbolts 1 1/2" hole, 1 3/4" thick Door

Model #8 4 1/4" x 4 1/2" For 2 3/4" BS

Finishes: Polished Brass (PB), Stainless Steel (S)

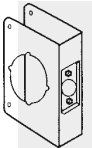

For Cylindrical Locks 2 1/8" hole, 1 3/4" thick Door

Model #61 4" x 4 1/2" For 2 3/8" BS

Finishes: Polished Brass (PB), Stainless Steel (S)

Model #81 4 1/4" x 4 1/2" For 2 3/4" BS

Finishes: Polished Brass (PB), Stainless Steel (S)

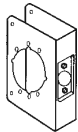

For Cylindrical Locks 2 1/8" hole, 1 3/4" thick Door, Heavy Duty Grade 1

Model #81-2 4 3/4" x 4 1/2" For 2 3/4" BS

Finishes: Polished Brass (PB), Stainless Steel (S)



For Mortise Lock 86 cut out, 1 3/4" thick Door

Model #504 5" x 12"

Finishes: Polished Brass (PB), Stainless Steel (S)

Note:

- Drill spindle and thumb turn holes in field
- 8" x 1/4" Recess