

Catalog Pages

RESIDENTIAL

ASTRAGALS

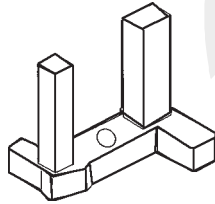

HD 056
Black

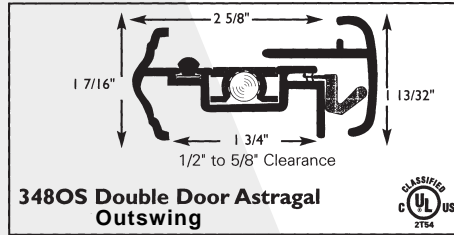

HD 093
Corner Fin Seal Pad
with adhesive backing

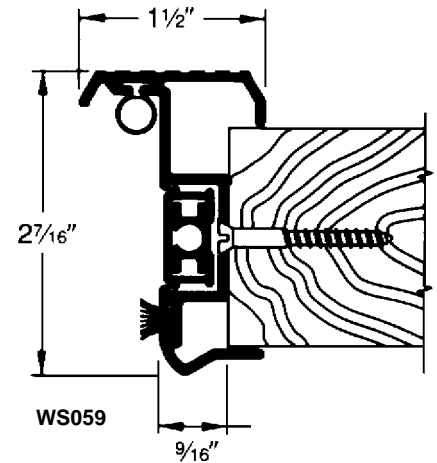

PART NO.	DESCRIPTION	LIST PRICE
10304	T-ASTRAGAL WITH FLUSH BOLT 6/8 - ALUMINUM	\$ 66.60
10305	T-ASTRAGAL WITH FLUSH BOLT 6/8 - BRONZE	\$ 83.70
10283	T-ASTRAGAL WITH FLUSH BOLT 6/8 - WHITE	\$ 80.80
10303	T-ASTRAGAL WITH FLUSH BOLT 6/8 - BRIGHT GOLD	\$ 97.50
10313	T-ASTRAGAL WITH FLUSH BOLT 8/0 - BRONZE	\$ 98.70
10311	T-ASTRAGAL WITH FLUSH BOLT 8/0 - WHITE	\$ 96.90
10312	T-ASTRAGAL WITH FLUSH BOLT 8/0 - ALUMINUM	\$ 81.00
10316	T-ASTRAGAL WITH FLUSH BOLT 8/0 - BRIGHT GOLD	\$ 120.00
06558	T-ASTRAGAL SHOE LEFT	\$ 4.00
06560	T-ASTRAGAL SHOE RIGHT	\$ 4.00
10272	CORNER SEAL PAD WHITE	\$ 0.70
10287	ASTRAGAL 6/8 ALUM 348OS	\$ 117.70
10288	ASTRAGAL 8/0 ALUM 348OS	\$ 141.60
10290	ASTRAGAL 6/8 BRONZE 348OS	\$ 124.30
10291	ASTRAGAL 8/0 BRONZE 348OS	\$ 150.00

237



SMOKE/AIR
Meet requirements of:
ASTM E-283
SDI 116

Products indicated by this symbol have been Air Infiltration Tested for smoke and draft control at 1.57PSF.



FIRE LABELED
Standards:
ASTM E-152 NFPA-252
UBC-432 UL-10(B)

Products indicated by this symbol unless noted otherwise are Listed and Labeled as Gasketing for use on Steel or Wood Frames with Wood or Steel Doors for 20 minute; 45 minutes, C-label; 1 hour, B-label; and 1-1/2 hour, B-label conditions. Consult Pemko Fire Labeled brochure for each product's specific label. Products in this catalog meet B label conditions unless noted otherwise.

ABS - AMERICAN BUILDING SUPPLY, INC.

Catalog Pages

RESIDENTIAL

SILLS

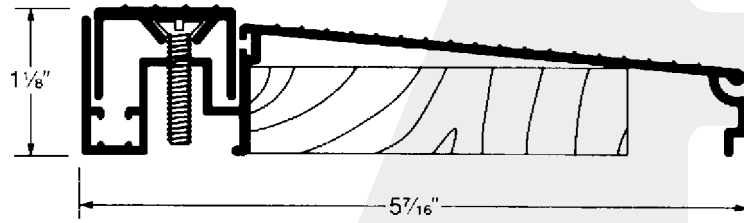

ADJUSTABLE SILL

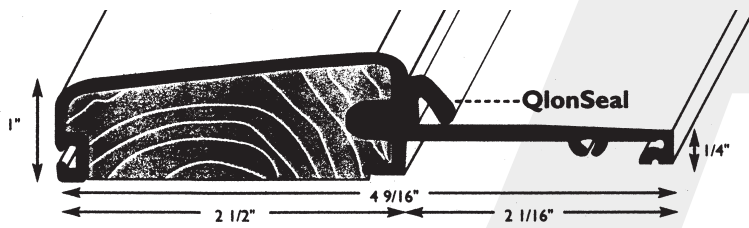

OUTSWING SILL

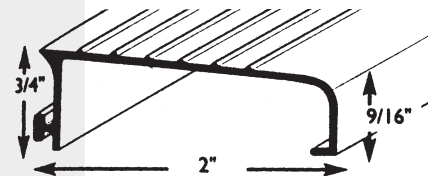

O/S SILL EXTENDER

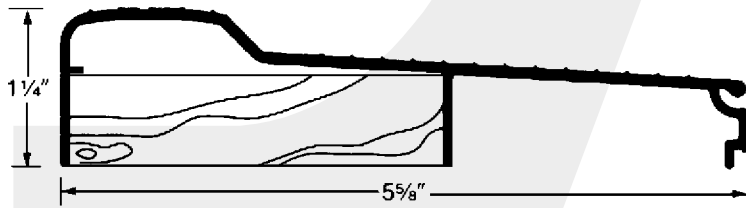

FIXED SILL

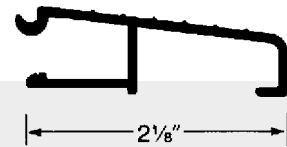

SILL EXTENDER

	2/6	2/8	3/0	6/0	12/4
1-1/8" X 5-5/8" ADJUSTABLE SILL - ALUM	\$ 27.40	\$ 28.60	\$ 31.00	\$ 61.50	
1-1/8" X 5-5/8" ADJUSTABLE SILL - BRONZE	\$ 35.00	\$ 38.10	\$ 41.80	\$ 75.60	
1" X 4-9/16" OUTSWING SILL - ALUM	\$ 18.40	\$ 19.50	\$ 21.90	\$ 44.50	\$ 88.00
1" X 4-9/16" OUTSWING SILL - BRONZE	\$ 24.80	\$ 25.50	\$ 28.50	\$ 57.50	\$ 118.00
3/4" X 2" O/S SILL EXTENDER - ALUM		\$ 6.30	\$ 7.10	\$ 13.80	\$ 29.10
3/4" X 2" O/S SILL EXTENDER - BRONZE		\$ 10.20	\$ 11.00	\$ 23.50	\$ 47.00
1-1/4" X 5-5/8" FIXED SILL - ALUM	\$ 16.50	\$ 17.70	\$ 19.80	\$ 39.60	\$ 81.50
1-1/4" X 5-5/8" FIXED SILL - BRONZE	\$ 21.00	\$ 22.30	\$ 25.10	\$ 50.30	\$ 103.30
1-1/4" X 5-5/8" FIXED SILL - BRITE GOLD			\$ 36.80	\$ 76.80	\$ 161.60
1-1/4" X 5-5/8" FIXED SILL - WHITE			\$ 48.60	\$ 97.80	\$ 169.20
2-1/8" SILL EXTENDER - ALUM			\$ 7.10	\$ 14.10	
2-1/8" SILL EXTENDER - BRONZE	\$ 8.10		\$ 9.90	\$ 19.70	

SHRINK WRAPPING AVAILABLE

UPC LABEL UPON REQUEST FOR STOCKING DEALER

Catalog Pages

RESIDENTIAL

WEATHERSEALS

PRICES ARE NET

PART NO.	DESCRIPTION	NET
10314	WEATHERSTRIP SCHLEGEL 3/0 -BRZ-EACH	\$ 0.50
10310	WEATHERSTRIP SCHLEGEL 6/8 -BRZ-PAIR	\$ 2.00
10317	WEATHERSTRIP SCHLEGEL 8/0 -BRZ-PAIR	\$ 2.30
10318	WEATHERSTRIP SCHLEGEL 3/0 -WHT-EACH	\$ 0.50
10325	WEATHERSTRIP SCHLEGEL 6/8-WHT-PAIR	\$ 2.00
10320	WEATHERSTRIP SCHLEGEL 8/0-WHT-PAIR	\$ 2.30

239

BOX QUANTITIES ONLY

- 6/8 Upright sold as 75 pair per box
- 8/0 Uprights sold as 60 pair per box
- Heads sold as 300 each to a box

KWIKSET

POCKET DOOR LOCKS

PART NO.	DESCRIPTION	FINISH
		10B, 15, 15A, US3, US5, 26D
9KWK334	PASSAGE POCKET DOOR LOCK	\$ 29.61
9KWK335	PRIVACY POCKET DOOR LOCK	\$ 32.87

240